

PLISSÈ ZERO

FISSAGGIO FRONTALE VEDI LISTINO PAG. 261

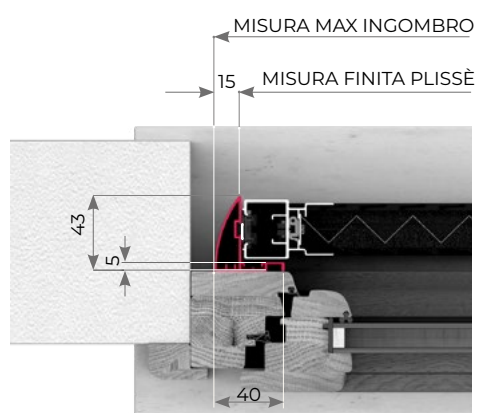

FISSAGGIO FRONTALE PLISSÈ ZERO

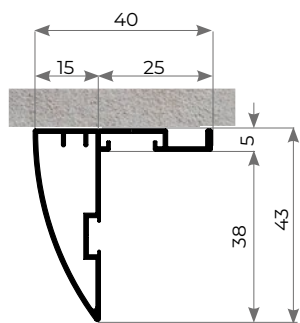

0.22 TOP

FISSAGGIO FRONTALE VEDI LISTINO PAG. 261

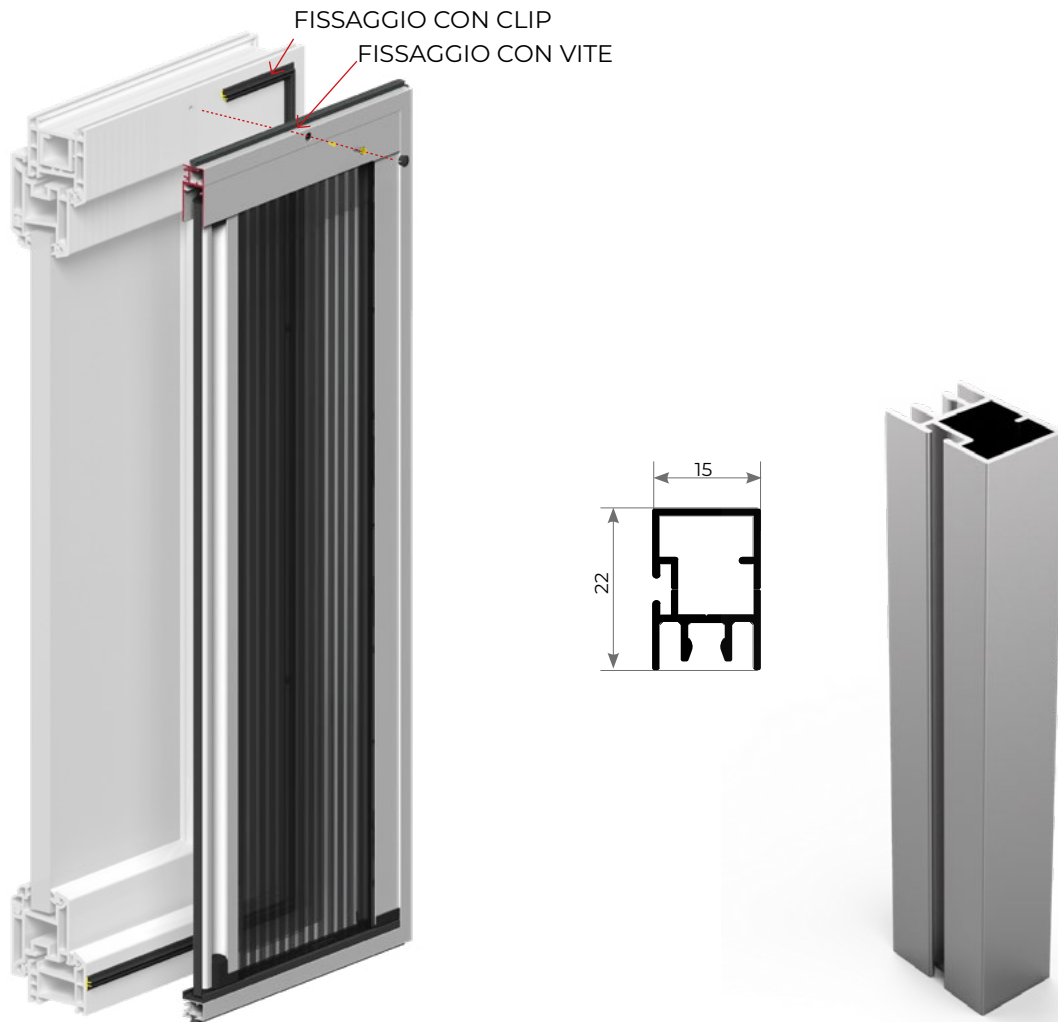

SEZ. ORIZZONTALE FISSAGGIO CON CLIP

SEZ. ORIZZONTALE FISSAGGIO CON VITE

0.22 TOP

FISSAGGIO FRONTALE VEDI LISTINO PAG. 261

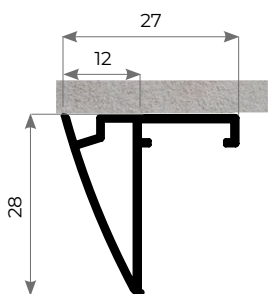
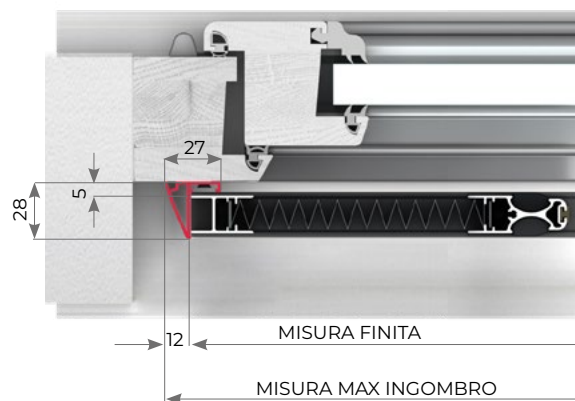
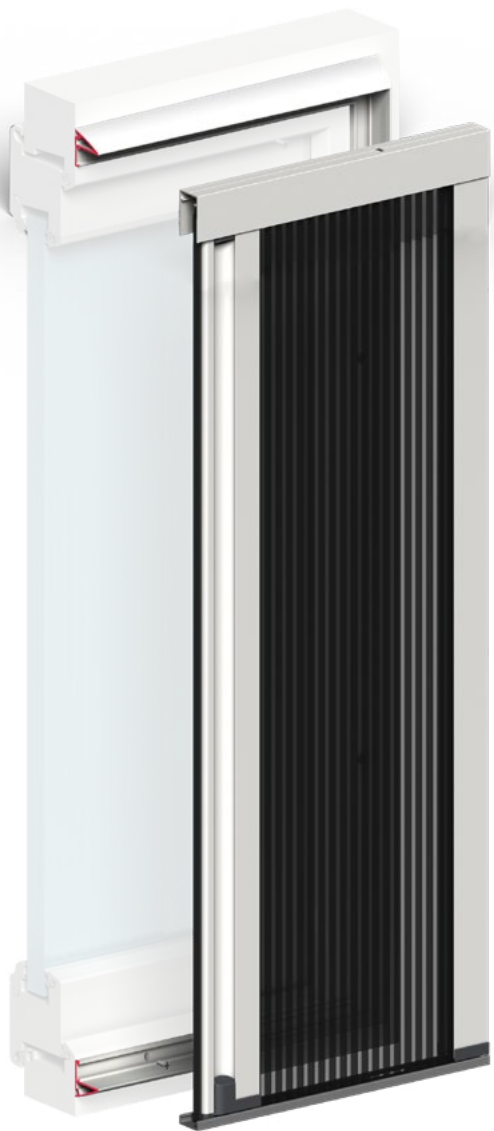

LIBERA - STAR 50 - JOLLY - FLEXA

FISSAGGIO FRONTALE VEDI LISTINO PAG. 261

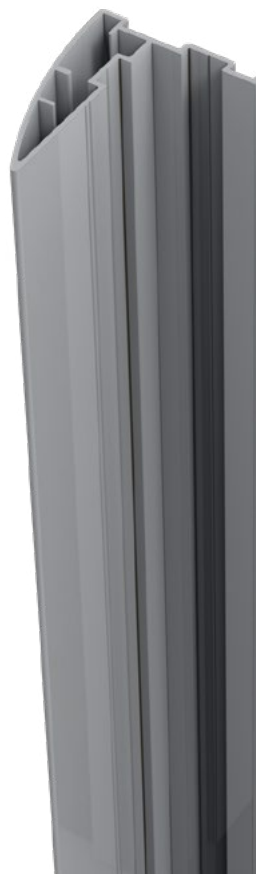
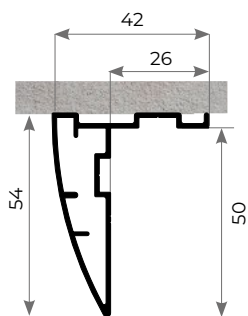
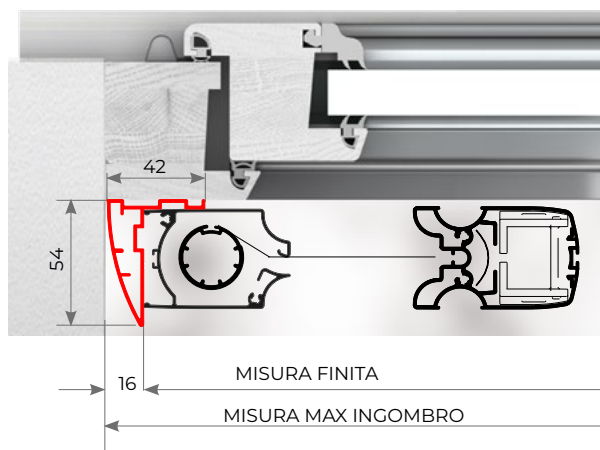
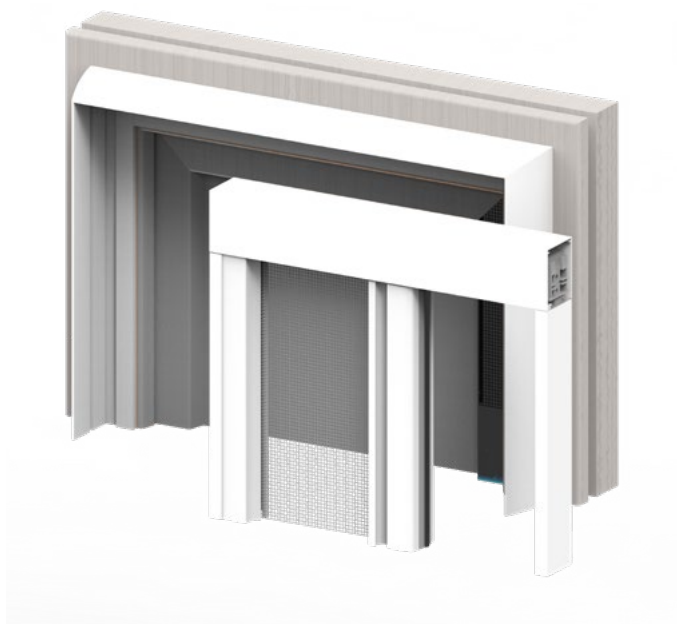

VARI

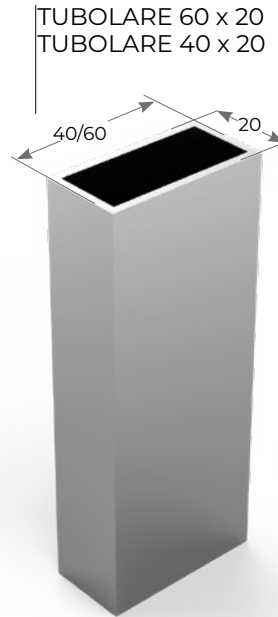
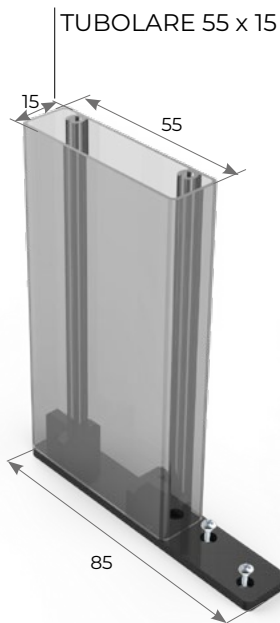

COLORI ALLUMINIO RAL STANDARD

* FINITURA SEMILUCIDA



BIANCO
9010
*



AVORIO
1013
*



MARRONE
8017
*



T. DI MORO
CHIARO



T. DI MORO
SCURO



VERDE
6005
*



BRONZO
VERNICIATO



ARGENTO
OX

A RICHIESTA ALTRI COLORI

La varietà delle finiture in uso nel mercato impone la soluzione a richiesta del colore dei profili di alluminio; l'azienda è in grado di offrire ulteriori colorazioni a preventivo.

PROFILO DI TAMPONAMENTO



UNIKA 50



KETTY

TUBOLARE 100 x 100

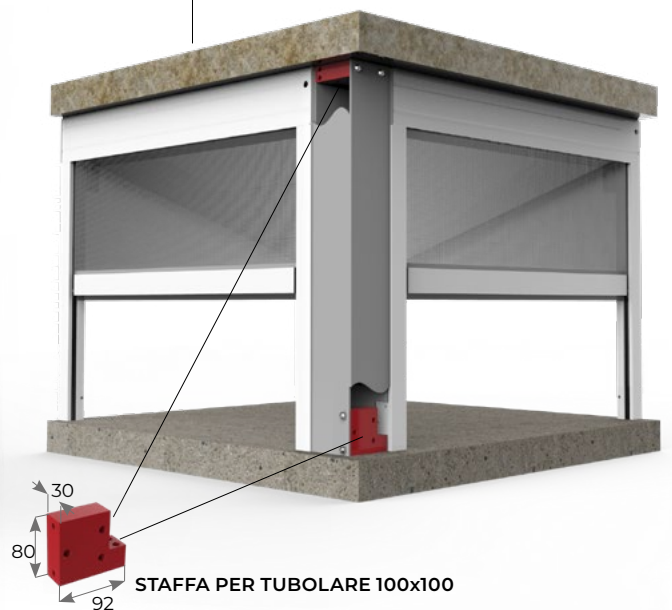

COLORI ALLUMINIO RAL STANDARD

▲ FINITURA RUVIDA



BIANCO
9010
▲

A RICHIESTA ALTRI COLORI

VERSIONI VISTE DALL'ESTERNO

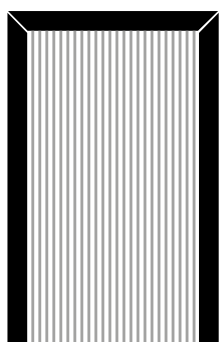

"A"

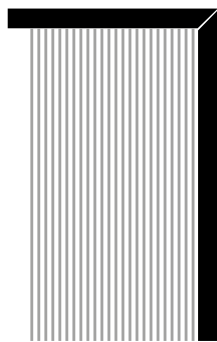

"B"

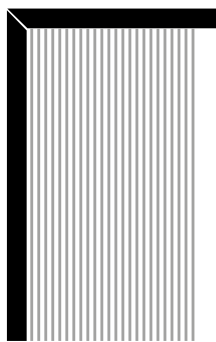

"C"

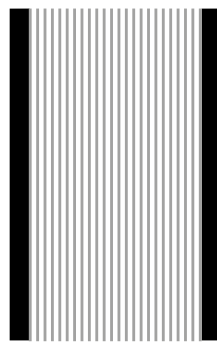

"D"

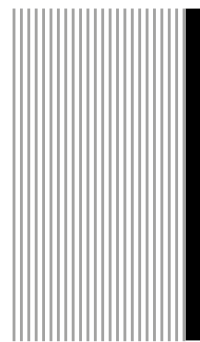

"E"

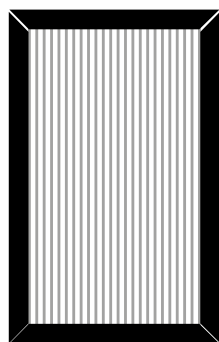

"F"

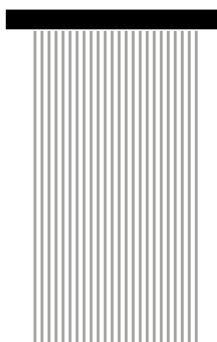

"G"

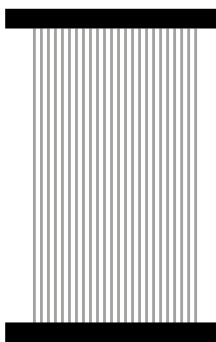

"H"

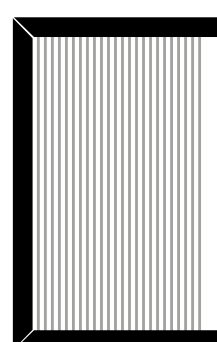

"I"

Le dimensioni della **Plissè - Jolly - Flexa - Libera - Star 50 - 0.18 - 0.22** a fissaggio frontale devono essere trasmesse in mm indicando base x altezza con le seguenti indicazioni.

MISURA FINITA ZANZARIERA: la zanzariera verrà fornita con le stesse misure indicate. Il kit verrà fornito con misure aumentate in relazione alla versione richiesta.

MISURA MAX INGOMBRO (SPECIFICARE): la zanzariera verrà fornita con dimensioni ridotte in relazione alla versione richiesta. Il kit verrà fornito con le stesse misure indicate.

ESEMPIO:

Per **Plissè - Jolly - Flexa - Libera - Star 50 - 0.18 - 0.22 fissaggio quadro** - misura max ingombro versione A (figura in alto), la zanzariera verrà fornita con dimensioni ridotte di 30mm in larghezza e 15mm in altezza.

Per **0.18 - 0.22 fissaggio tondo** misura max ingombro versione A (figura in alto), la zanzariera verrà fornita con dimensioni ridotte di 24mm in larghezza e 12mm in altezza.

LISTINO IVA ESCLUSA

KIT FISSAGGIO FRONTALE VERSIONE A - I	+€ 48,00 pz.
KIT FISSAGGIO FRONTALE VERSIONE B-C-D-H	+€ 37,00 pz.
KIT FISSAGGIO FRONTALE VERSIONE E - G	+€ 26,00 pz.
KIT FISSAGGIO FRONTALE VERSIONE F	+€ 68,00 pz.
PROFILO DI TAMPONAMENTO 50	€ 24,00 m
TUBOLARE 60 X 20	€ 19,00 m
TUBOLARE 40 X 20	€ 19,00 m
TUBOLARE 55 X 15	€ 16,00 m
TUBOLARE 100 X 100	€ 124,00 m
SET ACCESSORI X TUBOLARE 55X15 (2 STAFFE + VITERIA)	€ 8,00 pz.
SET ACCESSORI X TUBOLARE 100X100 (2 STAFFE + VITERIA)	€ 117,00 pz.

PREZZI VALIDI PER I COLORI **RAL** STANDARD.