

**PLISSÈ ZERO**

Articolo: ALLU2221

**FISSAGGIO FRONTALE** VEDI LISTINO PAG. 297

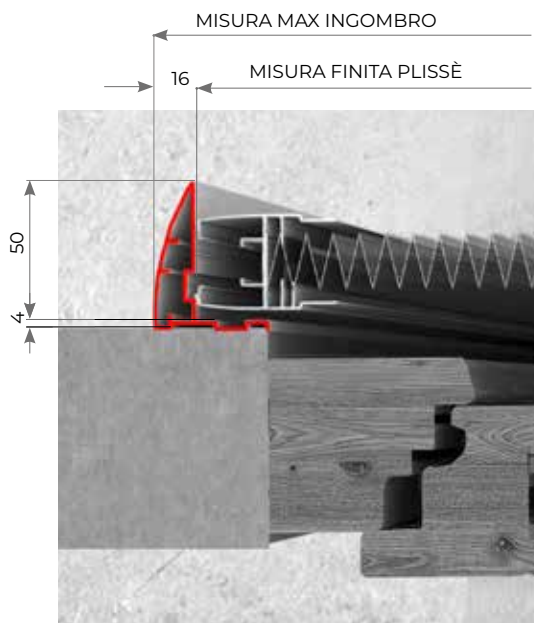

FISSAGGIO FRONTALE PLISSÈ ZERO

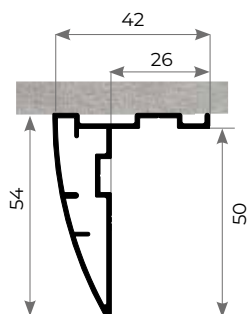

**0.22 TOP**

Articolo: ALLU0271

**FISSAGGIO FRONTALE** VEDI LISTINO PAG. 297

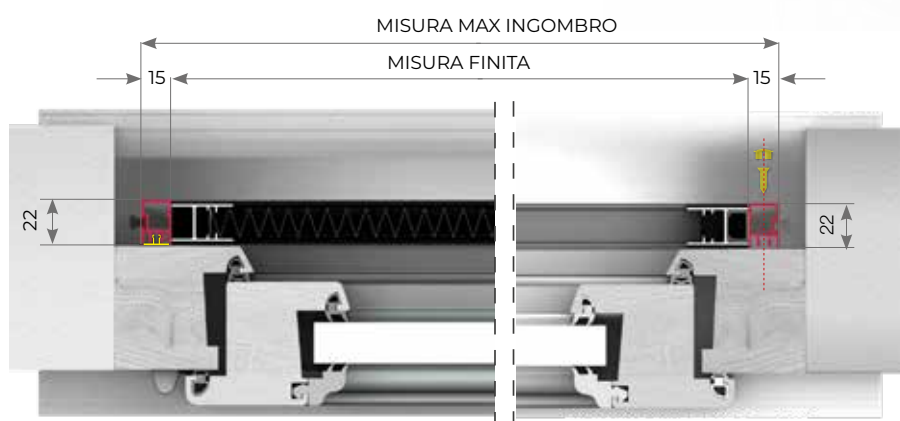
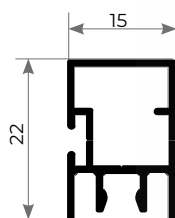

SEZ. ORIZZONTALE FISSAGGIO CON CLIP

SEZ. ORIZZONTALE FISSAGGIO CON VITE

**0.22 TOP**

Articolo: ALLU0257

**FISSAGGIO FRONTALE** VEDI LISTINO PAG. 297

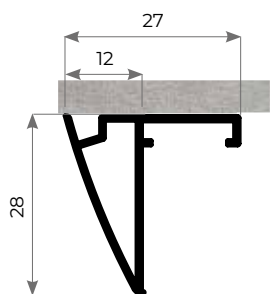
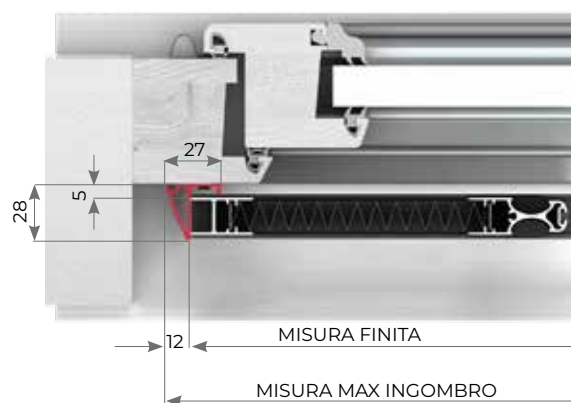

**LIBERA - STAR 45 - JOLLY - FLEXA**

Articolo: ALLU2221

**FISSAGGIO FRONTALE** VEDI LISTINO PAG. 297

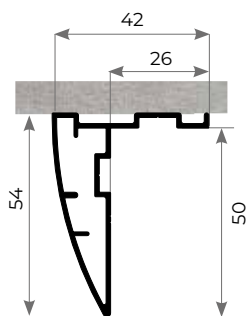
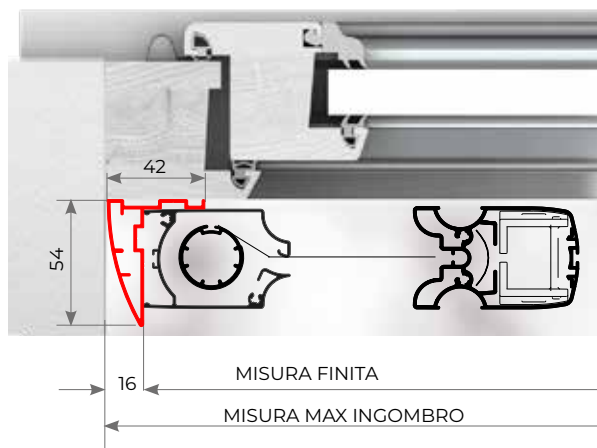

**VARI**

TUBOLARE 55 x 15

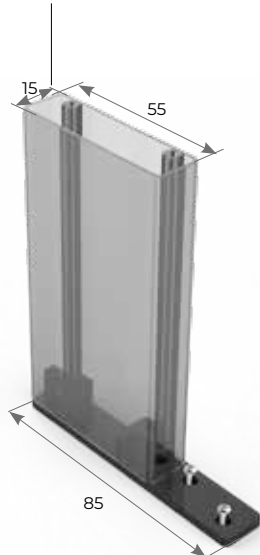

TUBOLARE 60 x 20  
TUBOLARE 40 x 20



**COLORI ALLUMINIO RAL STANDARD**

\* FINITURA SEMILUCIDA



BIANCO  
9010

\*



AVORIO  
1013

\*



MARRONE  
8017

\*



T. DI MORO  
CHIARO



T. DI MORO  
SCURO



VERDE  
6005

\*



BRONZO  
VERNICIATO



ARGENTO  
OX

**A RICHIESTA ALTRI COLORI**

La varietà delle finiture in uso nel mercato impone la soluzione a richiesta del colore dei profili di alluminio; l'azienda è in grado di offrire ulteriori colorazioni a preventivo.

PROFILO DI  
TAMPONAMENTO



UNIKA 50



KETTY

TUBOLARE 100 x 100

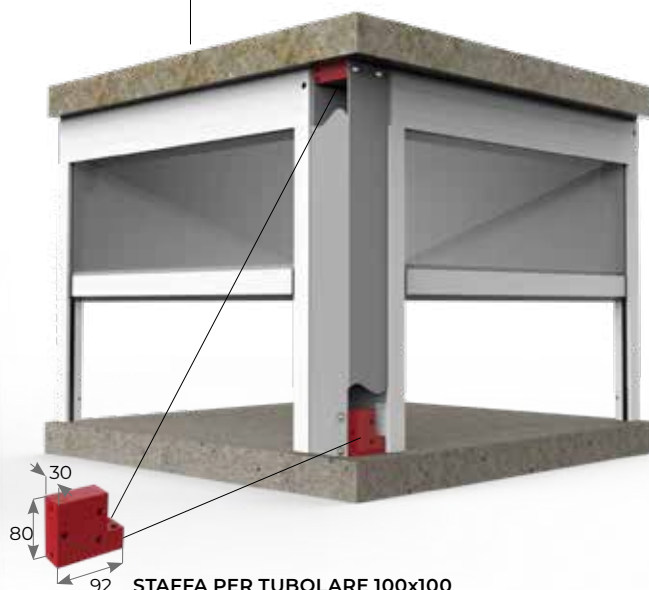

STAFFA PER TUBOLARE 100x100

**COLORI ALLUMINIO RAL STANDARD**

▲ FINITURA RUVIDA



BIANCO  
9010

▲

**A RICHIESTA ALTRI COLORI**

**VERSIONI VISTE DALL'ESTERNO**

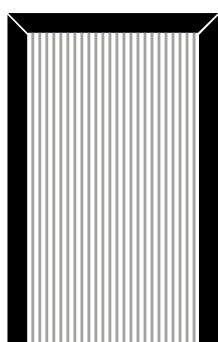

"A"

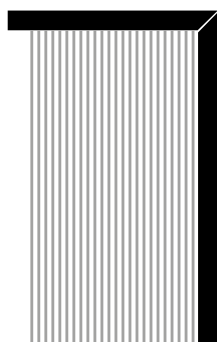

"B"

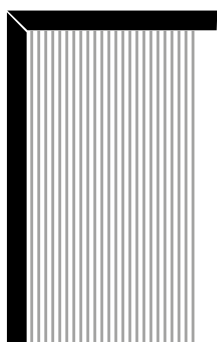

"C"

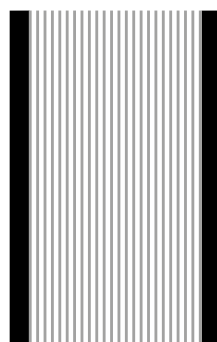

"D"

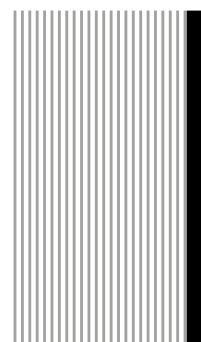

"E"

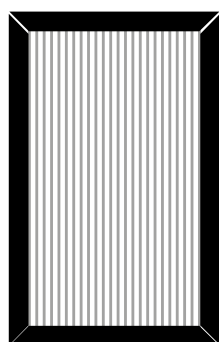

"F"

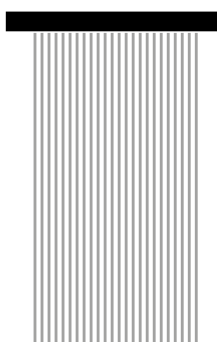

"G"

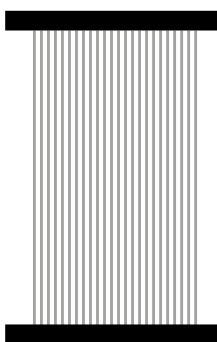

"H"

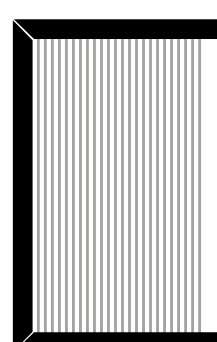

"I"

Le dimensioni della **Plissé - Jolly - Flexa - Libera - Star 45 - 0.18 - 0.22** a fissaggio frontale devono essere trasmesse in mm indicando base x altezza con le seguenti indicazioni.

**MISURA FINITA ZANZARIERA:** la zanzariera verrà fornita con le stesse misure indicate. Il kit verrà fornito con misure aumentate in relazione alla versione richiesta.

**MISURA MAX INGOMBRO (SPECIFICARE):** la zanzariera verrà fornita con dimensioni ridotte in relazione alla versione richiesta. Il kit verrà fornito con le stesse misure indicate.

**ESEMPIO:**

Per **Plissé - Jolly - Flexa - Libera - Star 45 - 0.18 - 0.22 fissaggio quadro** - misura max ingombro versione A (figura in alto), la zanzariera verrà fornita con dimensioni ridotte di 30mm in larghezza e 15mm in altezza.

Per **0.18 - 0.22 fissaggio tondo** misura max ingombro versione A (figura in alto), la zanzariera verrà fornita con dimensioni ridotte di 24mm in larghezza e 12mm in altezza.

**LISTINO IVA ESCLUSA**

KIT FISSAGGIO FRONTALE VERSIONE A - I	+€ 50,00 pz.
KIT FISSAGGIO FRONTALE VERSIONE B-C-D-H	+€ 39,00 pz.
KIT FISSAGGIO FRONTALE VERSIONE E - G	+€ 28,00 pz.
KIT FISSAGGIO FRONTALE VERSIONE F	+€ 72,00 pz.
PROFILO DI TAMPONAMENTO 50	€ 27,00 m
TUBOLARE 60 X 20	€ 20,00 m
TUBOLARE 40 X 20	€ 20,00 m
TUBOLARE 55 X 15	€ 16,50 m
TUBOLARE 100 X 100	€ 127,00 m
SET ACCESSORI X TUBOLARE 55X15 (2 STAFFE + VITERIA)	€ 8,20 pz.
SET ACCESSORI X TUBOLARE 100X100 (2 STAFFE + VITERIA)	€ 120,00 pz.

PREZZI VALIDI PER I COLORI **RAL** STANDARD.