

INCASSO A

INCASSO 47 + LIBERA

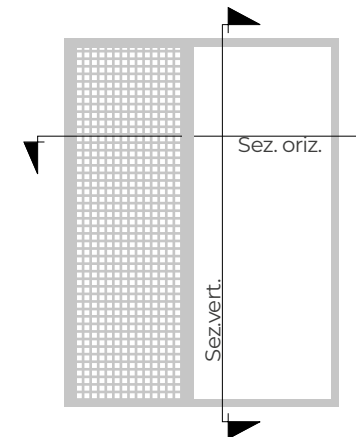

SEZIONE ORIZZONTALE

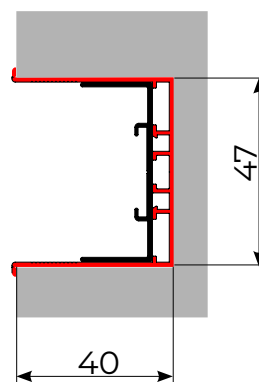
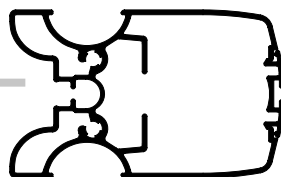
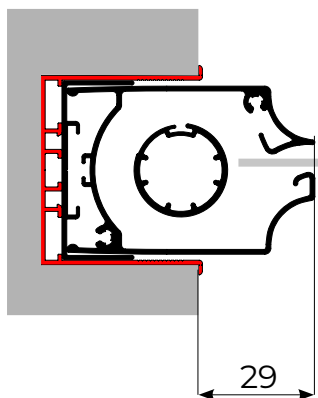

SEZIONE VERTICALE

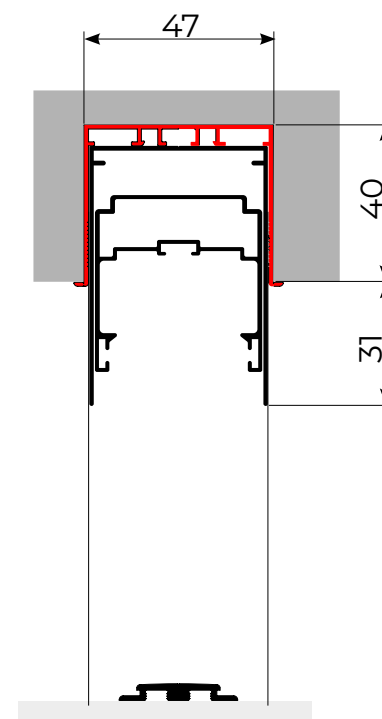

INCASSO B

INCASSO 50 + LIBERA



SEZIONE ORIZZONTALE

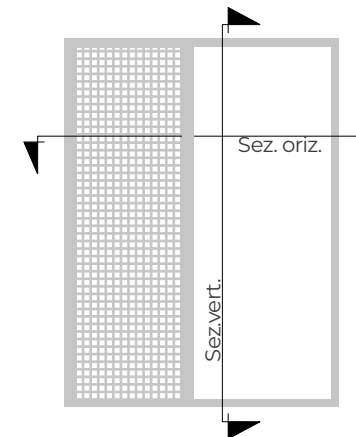
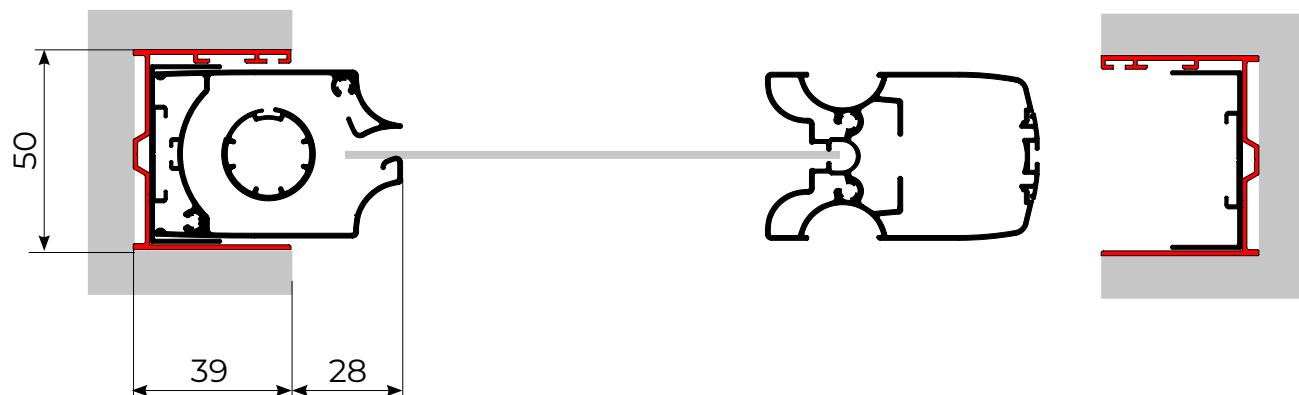

SEZIONE VERTICALE

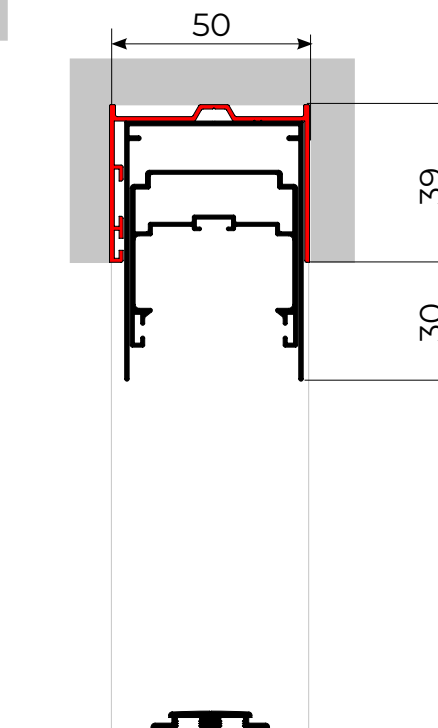

INCASSO C

DOUBLE FACE + LIBERA



SEZIONE ORIZZONTALE

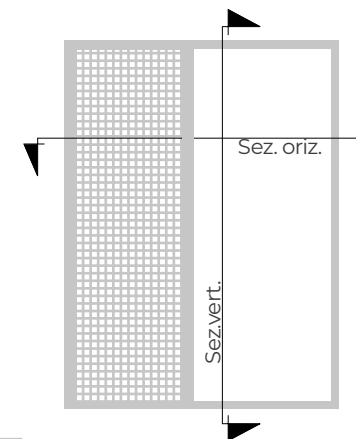
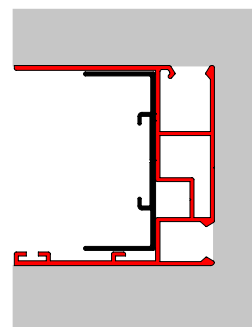
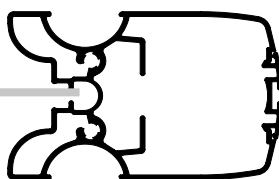
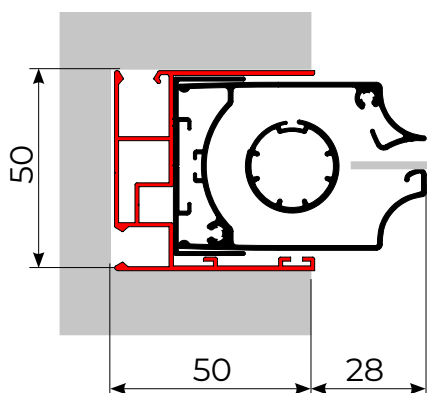

SEZIONE VERTICALE

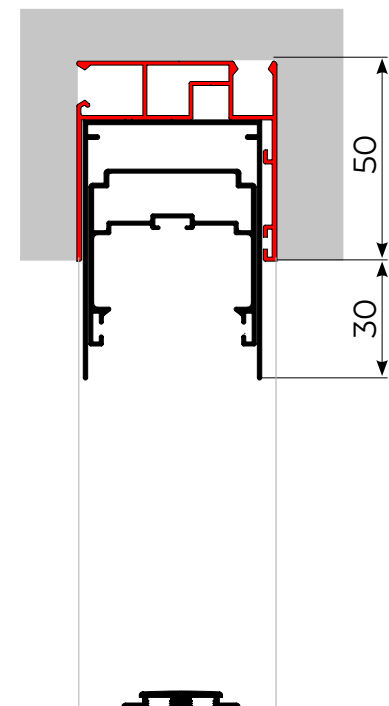

INCASSO D

TAPPARELLA + LIBERA



SEZIONE ORIZZONTALE

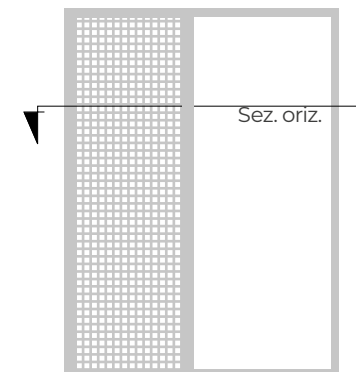
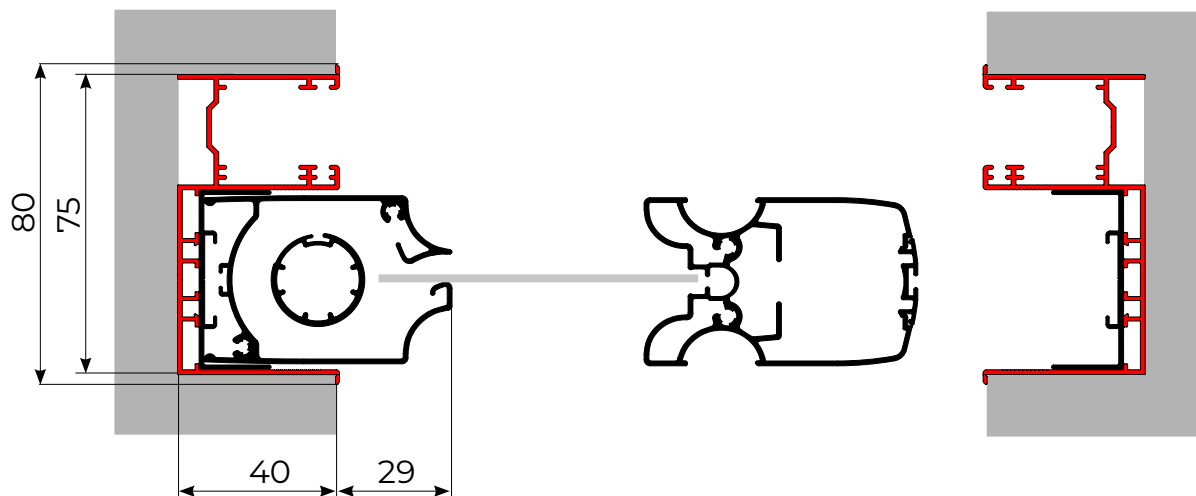

Sez. oriz.

INCASSO D

TAPPARELLA + DISTANZIALE + LIBERA



SEZIONE ORIZZONTALE

